

# CONCEPTUAL DESIGN OF SELF-OPTIMIZING SYSTEMS EXEMPLIFIED BY A MAGNETIC LINEAR DRIVE\*

Prof. Dr.-Ing. J. Gausemeier<sup>1</sup>, Prof. Dr.-Ing. Detmar Zimmer<sup>2</sup>, Dr.-Ing. U. Frank<sup>1</sup>,  
Dipl.-Inf. Sebastian Pook<sup>1</sup>, Dipl.-Ing. Alexander Schmidt<sup>2</sup>

<sup>1</sup> Heinz Nixdorf Institute, University Paderborn, Germany

<sup>2</sup> KAt, University Paderborn, Germany

## ABSTRACT

The conceivable development of information technology will enable mechatronic systems with inherent partial intelligence. We call this kind of systems self-optimizing. Self-optimizing systems are able to react autonomously and flexible to changing environmental conditions. They are capable of learning and optimizing their behavior at run-time. This paper presents the paradigm of self-optimization and shows in which way the principle solution of these systems, the result of the conceptual design phase, should be specified. Furthermore, this paper describes how to analyze whether the developing system should be implemented self-optimized or not. How the methods work we explain by the complex magnetic linear drive of a shuttle.

*Keywords: Design Methodology, Mechatronics, Identification from self-optimizing potencial, Specification Techniques*

## 1 INTRODUCTION

The development of the information and communication technology opens fascinating perspectives for mechanical engineering: mechatronic systems with inherent partial intelligence. We use the term self-optimization for these systems. Self-optimization enables mechatronic systems to react independently and flexible according to changing operating conditions. The design of such systems is a challenge. The already established development methodologies in the areas of classical mechanical engineering [1] and mechatronics, for example the VDI Guideline 2206 "Design methodology for mechatronic systems" [2], are not sufficient here. This concerns in particular to the early phases "planning and clarifying the task" and "conceptual design". The result of this phase is the principle solution. The principle solution specifies the fundamental structure and the fundamental mode of action of the system. Therefore it should be determined at this point whether a system is self-optimized or not.

A new design methodology for self-optimizing systems is developed at the Collaborative Research Centre (SFB) 614 "Self-Optimizing Concepts and Structures in Mechanical Engineering" of the university of Paderborn. An important component of this design methodology is a method for the identification of self-optimization potential. This contribution describes first the paradigm of self-optimization. Then it represents a specification technology for describing the principle solution of self-

---

\* This contribution was developed in the course of the Collaborative Research Center 614 "Self-Optimizing Concepts and Structures in Mechanical Engineering" (Speaker: Prof. Gausemeier) funded by the German Research Foundation (DFG) under grant number SFB 614.

optimizing systems and a method for the identification of self-optimization potential. Finally it describes how to use the methods in the conceptual design phase of a test bench, which is made to optimize the efficiency of a linear motor.

## 2 SELF-OPTIMIZATION

The key aspects and the mode of operation of a self-optimizing system are illustrated in Figure 1. The objectives pursued by the system play an important role. The self-optimizing system determines its currently active objectives on the basis of the encountered influences. For example, while a rail system is in normal operation mode the objectives include a high level of comfort and minimal power consumption.

The self-optimizing system is able to adapt its objectives autonomously. This means, for instance, that the relative weighting of the objectives is modified, new objectives are added or existing objectives are discarded and no longer pursued. Adapting the objectives in this way leads to adaptation of the system behavior. That is achieved by adapting the parameters and where necessary the structure of the system. The term parameter adaptation means adapting a system parameter, for instance changing a control parameter. Structure adaptations affect the arrangement of the system elements and their relationships.

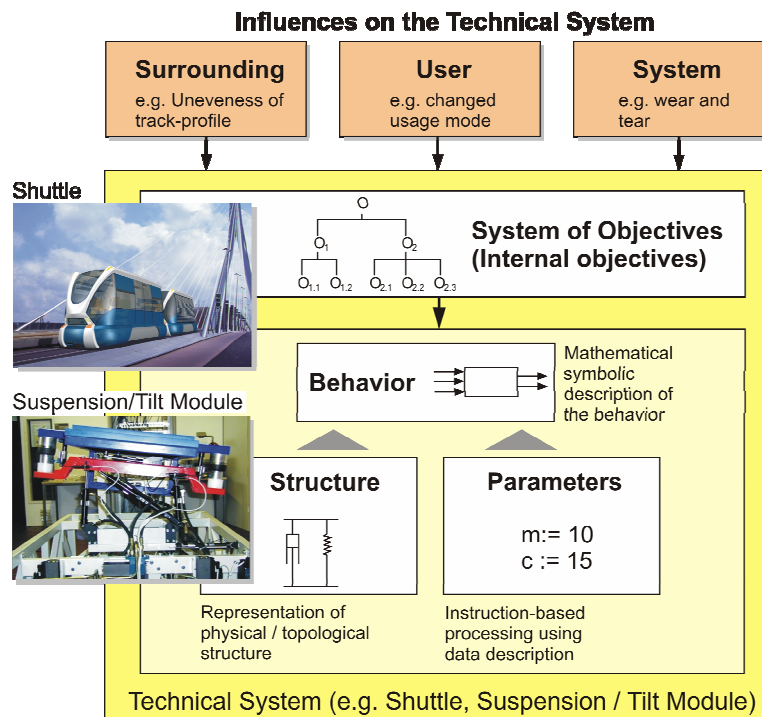

Figure 1. Aspects of self-optimization systems [3]

We express self-optimization as a series of three actions that are generally carried out repeatedly:

- 1) **Analyzing the current situation:** Here the current situation includes the state of the system itself and all the observations that have been made about its environment. Such observations may also be made indirectly by communicating with other systems.
- 2) **Determining the system of objectives.**
- 3) **Adapting the system behavior** according to the new objectives.

This sequence of actions is called a **self-optimization process**. From a given initial state, the self-optimization process passes, on the basis of specific influences, into a new state, i.e. the system undergoes a state transition.

### 3 RELATED WORK

There are a wide variety of approaches to the specification of technical systems in the early phases of product development. All of them fundamentally map the elements of the system and their interrelations, but no approach specifies the self-optimization process. ModCoDe – a system for the object-oriented modeling of mechatronic product concepts – models active elements and their interrelationships, including associated behavior models, described by means of block diagrams, state charts and bond graphs [4]. SchemeBuilder is a development tool for modeling and simulating conceptualized mechatronic systems by mapping and linking functions, active principles and components. Formulating behavior models enables simulation models to be derived automatically [5]. The emphasis here is on mapping kinematic, dynamic and control behavior.

Suh subdivides the description of technical systems into the domains: customer, function, physics and process. He formally models the domains and the relationships between them. He defines axioms that enable him to derive modules and determine the ideal solution concept. The formal specification can also be used as the basis for establishing the system's stability [6]. In Buur's work on the description of mechatronic concepts the emphasis is on modeling functions depending on system states and state transitions [7]. The specification technique for describing mechatronic systems developed by the project iViP focused on mapping models to describe requirements, functions, structures, constraints and shape and the cross-links between them [8].

The ordering concept CARTRONIC [9] and the specification technique for modeling mechatronic machine tool concepts that was formulated during the project "Planning mechatronic production systems" [10] both utilize software specification techniques such as UML. Here the focus is on communication relationships. An OMG consortium formulated SysML™ (System Modeling Language), which is a standard based on UML for the specification, analysis, verification and validation of technical systems. Here the emphasis is on modeling system structures, parameters, requirements and behavior (such as the system's activities, states and interactions) [<http://www.omg.sysml.org/>]. Methods for identifying the self-optimization potential are not known to the authors.

### 4 SPECIFICATION TECHNIQUE FOR THE PRINCIPLE SOLUTION

In order to describe the principle solution of a self-optimizing system we use a set of semi-formal specification techniques [11]. For a complete description we need several views on the self-optimizing system. The developed set of specification techniques allows describing these views and how they are interlinked. Each view is mapped by computer onto a partial model. As shown in Figure 2, the principle solution is made up of the following eight views respectively partial models: requirements, environment, system of objectives, functions, active structure, shape, application scenarios and behavior. This last view is considered a group because there are various types of behavior (e.g. the logic behavior, the dynamic behavior of a multi-body system, the cooperation behavior of system components etc.). There are also relationships between the partial models, leading to a coherent system of partial models that represents the principle solution of a self-optimizing system.

Previously, in mechatronics, the focus was normally on the system's active structure, but here the system's states and state transitions are in the foreground, i.e. the self-optimization process and its effects on the active structure and the processes taking place within the system.

These partial models are worked out not sequentially, but interactively. Each of the development steps undergoes numerous iterations, and the order in which they are carried out will depend upon the object being developed, organizational constraints, and – especially – on the preferred approach of the individual developer and the use of a suitable methodology (cf. [12]).

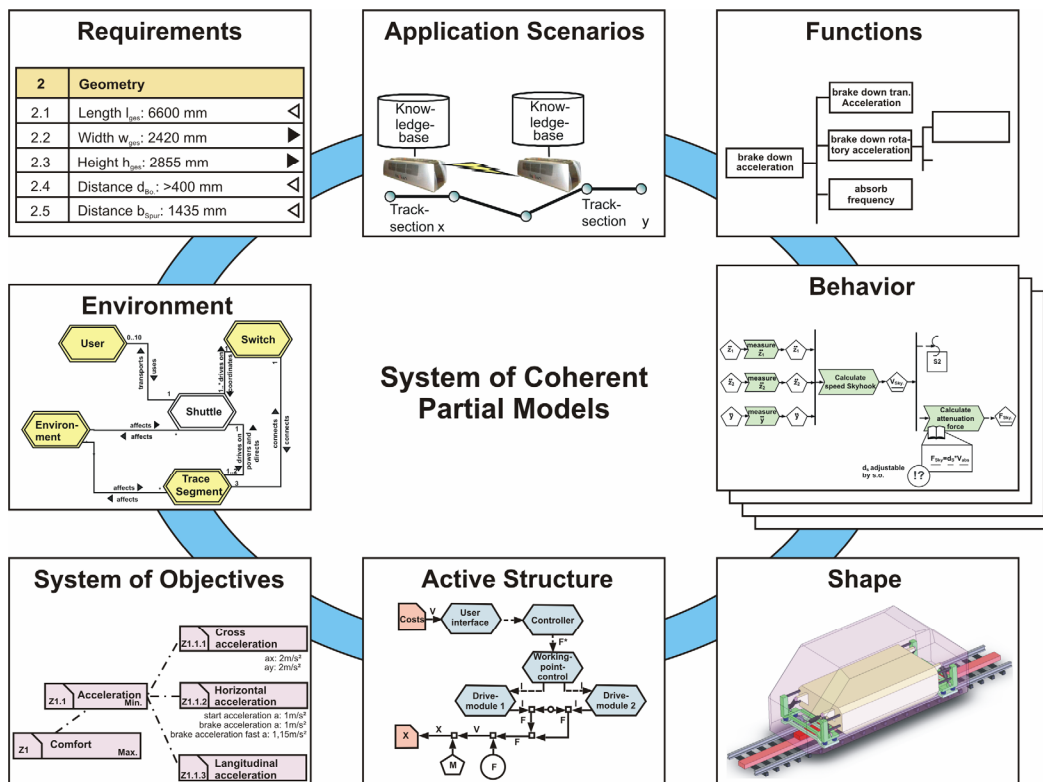

Figure 2. Coherent system of partial models for describing the principle solution of a self-optimizing system

## 5 IDENTIFICATION OF SELF-OPTIMIZATION POTENTIAL

The result of the development is to achieve a system without weak points. In order to reach this goal, the contradictions and weak points must be identified and eliminated during the development of the principle solution. The paradigm of self-optimization is a possibility to dissolve contradictions and eliminate weak points. However, it is to be examined firstly whether self-optimization is suitable for each specific case. The steps synthesis, analysis and evaluation of the system are continually executed during the development of the principle solution. For the identification of self-optimization potential the phases represented in Figure 3 have to be added to the analysis of the system.

**General system analysis:** The goal is the investigation of parameters and system structures, which can be changed within certain boundary conditions in such a way that they enable dissolving contradictions and eliminating weak points. Firstly the weak points and contradictions are to be identified. An example of a weak point of a drive is not reaching the demanded driving power. Then, each specific case should be analyzed. The task is to find out which influence of the environment (e.g. wind force, heat force) and of the system (system parameter and structures, e.g. adjusting forces) affect this weak point and/or these contradictions. In addition, we use the influence analysis and the analysis of physical regularities. Afterwards it is to examine whether the identified influences can be controlled or regulated by the system in such a way that the weak point is eliminated and the contradiction is solved. We call the regulating influences (parameters and structures) adjustable parameters and structures. At last, boundary conditions for these adjustable parameters and structures are to be investigated. The partial models active structure and environment are the basis for this phase. The result of the general system analysis is possible weak points and contradictions within the system and adjustable parameters and structures, with which the system can dissolve the weak points and contradictions within certain limitation.

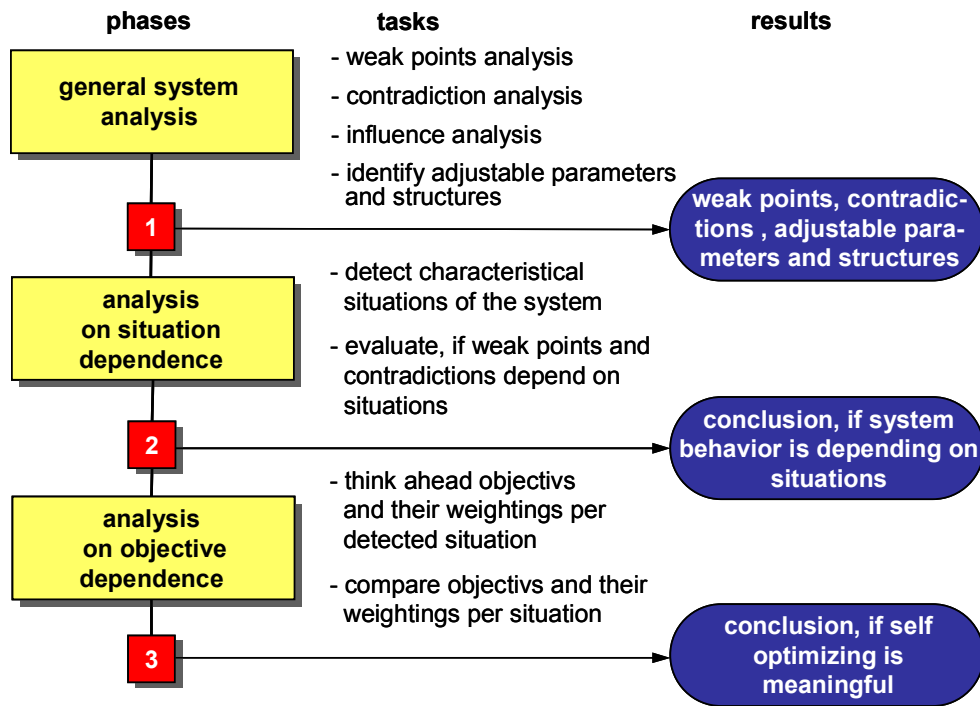

Figure 3. Approach for the identification of self-optimization potential

**Analysis on situation dependence:** The goal is to present in detail, whether the system behaves differently due to changing influences. The influences on the system can depend on way and time, i.e. they are not always equivalent intensively present. In the first step, the influences will be analyzed on occurrence frequency and occurrence duration. Then important characteristic situations are investigated for the system. Therefore consistent bundles of influences occurring at the same time are formed and summarized to situations. Afterwards, it is to analyze, in which situations which weak points and contradictions occur. If different weak points and contradictions occur in different situations, we speak of situation-dependence of the weak points and contradictions. The partial model environment is relevant for these investigations. The result of this phase is the statement whether the weak points and contradictions are situation-dependent or not.

**Analysis on objective dependence:** The key of self-optimization is that the system determines its optimization objectives independently and adapts its behaviour through parameter and structural change if necessary. The system optimizes itself in dependence of its situation. In this phase, optimal adjustable parameters and structures for the situations are investigated to achieve an optimal behavior. Afterwards, objectives and their weightings are thought of for each situation. Then the objectives and their weightings will be compared in each situation. If all objectives and their weightings are the same in each situation, the system does not have to be self-optimizing. A simple regulation or adaptation is sufficient in this case. If different objectives or if different weightings of the objectives are relevant in the situations, the system should be self-optimizing.

## 6 APPLICATION EXAMPLES

The procedure described above will be clarified in the following on the basis of the example "linear drive of a shuttle". Autonomous shuttles build the core of the innovative rail system "Neue Bahntechnik Paderborn/RailCab". The rail system is realized at the university of Paderborn as a surrounding test station on a scale of 1:2,5 [http://nbp.www.upb.de]. This rail system acts as a demonstrator for the SFB 614. The drive of the shuttles is developed with the help of a doubly fed linear drive. Its stator is placed between the rails; the rotor is fastened to the shuttle. The three-phase alternating current coils lying in the stator produce a magnetic field, which moves itself along the rail. The magnetic force effect is developed in the air gap between stator and rotor magnetic field. The active structure in Figure 5 on the left clarifies the section of the regarded system in this contribution. It specifies a shuttle and a rail section as system elements, which consist of subsystem elements such as carrying structure (frame) and rotor or stator and track in each case. The stator and the rotor are combined into the logi-

cal group linear motor. The rotor current  $I_L$  and the stator current  $I_S$  flows into the rotor and stator. It produces a magnetic field. The drive and brake force  $F$  results from this magnetic field. The system parameters magnetic air gap and indirectly the mechanical air gap affect the drive and brake force  $F$ .

An advantage of the linear motor is that the contact between the wheel and the rail is not used for the transmission of the drive and brake force. Furthermore, the function "transfer the energy into the vehicle" is realised by the drive. Overhead lines or power rails can be omitted in this way. The disadvantage of this innovative drive principle is the lower efficiency compared to conventional, gyratory three-phase induction motors (TPIM) which provides comparable performance (Figure 4) [13].

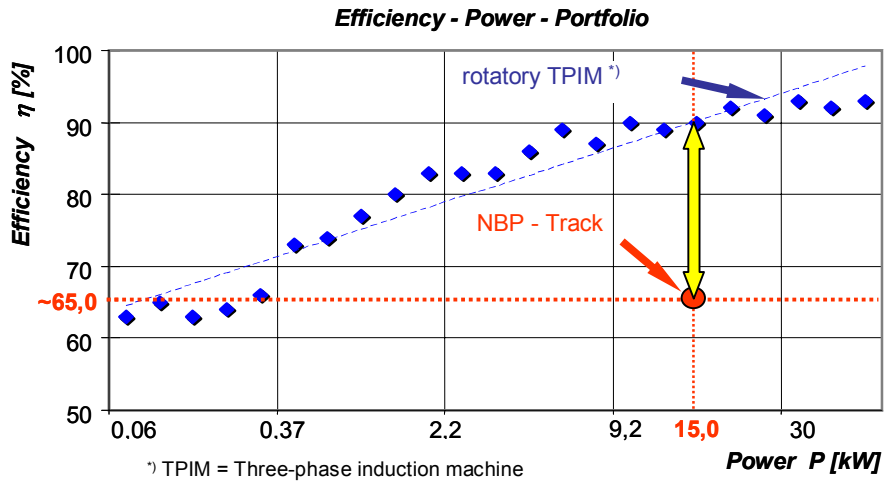

Figure 4. Efficiency – Power - Portfolio

The analysis in the following sections demonstrates that the efficiency of the linear motor can be improved with a self-optimizing concept. The last section presents a concept for the improvement of the efficiency, which uses the paradigm of self-optimization.

## 6.1 General System Analysis

It is to be analyzed in the first step, which parameters and structures affect the efficiency within the system. For this purpose, all relevant parameters of the system that are identified in the active structure are registered in an influence matrix. Their influence to each other will be estimated (Figure 5). The estimation is made under the generally accepted physical regularities. This will be described in the following:

The efficiency of the linear motor can be indicated on the basis of the generally accepted description of the efficiency by the relationship of the usage to the expenditure:

$$\begin{aligned} \eta &= \frac{\text{effective mechanical power } (P_{mech})}{\text{injected electrical power } (P_{el})} \\ &= \frac{F \cdot v}{U \cdot I} = \frac{P_{el} - P_v}{P_{el}} = 1 - \frac{P_v}{P_{el}} \end{aligned} \quad (\text{equation 1})$$

According to Grothstollen's [14] theory the drive and brake force  $F$  can be calculated:

$$F = \frac{3\pi}{\tau_P} \cdot L_{SL} \cdot (I_S \cdot I_L \cdot \sin \vartheta) \quad (\text{equation 2})$$

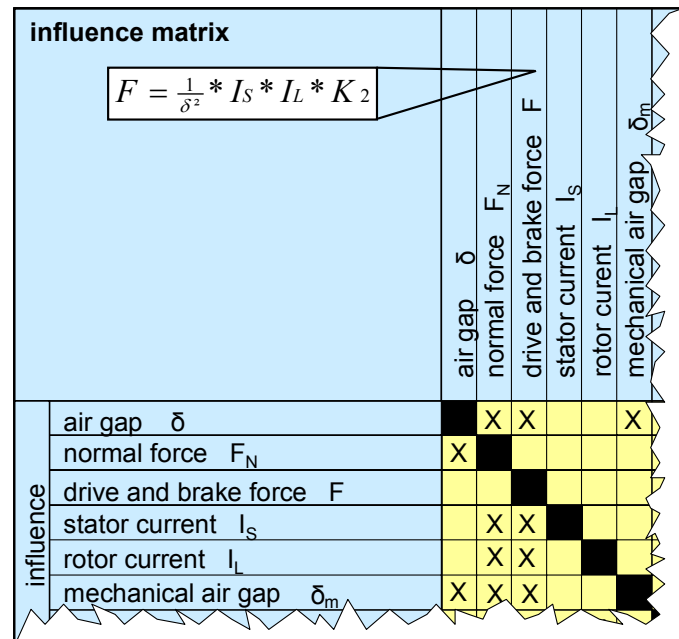
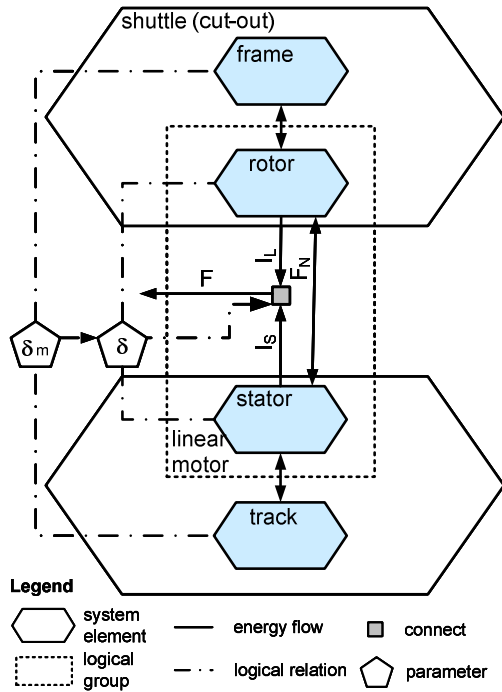

Figure 5. Left: Cu-tout from the active structure of the shuttle with a linear drive; Right: Cut-out from the influence analysis of the system

The mutual inductance of the rotor and stator coils  $L_{SL}$  results from the reciprocal value of the air gap multiplied by a factor  $K_1$  [15]:

$$L_{SL} = \frac{1}{\delta} \cdot K_1 \tag{equation 3}$$

The factor  $K_1$  contains the effective numbers of turns in rotor and stator, in the magnetic field constant, the pole pair number, the pole width and the pole division. The mutual inductance  $L_{SL}$  of the stator and rotor sinks thus with rising air gap. The following simplified association is conducted as a result of using equation (3) into equation (2) under the assumption that the phase angle between stator and rotor current  $\psi$  between rotor current  $I_L$  and stator current  $I_S$  lie in  $\pm 90^\circ$ :

$$F = \frac{1}{\delta} \cdot I_S \cdot I_L \cdot K_2 \tag{equation 4}$$

The factors  $K_2$ , as well as the factor  $K_1$ , summarize the values that can not be influenced, e.g. the magnetic field constant or the pole division.

An improved efficiency results according to equation 1, if an enhancement of the drive and brake force  $F$  can be achieved with equal lasting electrical performance  $P_{el}$ . The equation 4 shows that the air gap should be as small as possible for this purpose. In the next step, it is investigated whether the air gap can be minimized to any value or whether there are restrictions for it. Investigations of the system design shows that the actually adjustable air gap is smaller than the magnetic one. The magnetic air gap is the distance between the coils of the rotor and the stator which build magnet fields. Both the rotor and stator coils do not lie openly. They are embedded in a potting compound. Thereby the substantially smaller mechanical air gap  $\delta_m$  is resulted. Now it is to be analyzed whether this can be minimized to any value or whether there are further restrictions.

The mechanical air gap can not be minimized to any value to avoid the contact of the rotor and the stator. For example, the air gap of the shuttles is adjusted to 10 mm at present. This relatively large air

gap makes the engine durable in relation to small deviations of the distance from its ideal condition. It provides thus a higher security against a collision of the rotor and the stator. However, a small efficiency results under these circumstances. Additionally, the normal force  $F_N$  has influence on the air gap. It results from the magnetic field between the rotor and the stator and can be expressed simplified as following:

$$F_N = \frac{1}{\delta^2} \cdot I_S \cdot I_L \cdot K_3 \quad (\text{equation 5})$$

A high normal force leads to increased burden of the wheel bearings and the carrying structure. It has thus a higher wear of the burdening shuttle components [13]. A contradiction between the design goals "a small air gap as possible" and "a low normal force as possible" occurs as a consequence. We analyze in the end, which influences of the environment affect the air gap and whether these values can be affected by the system shuttle. For this purpose, the relevant influences in the partial model environment are to be identified and opposed in an influence matrix. Shifting tolerances, temperature influences, storage mistakes, setting in the gravel, and also wear of wheels and rails have influence on the air gap for example. The system can affect only the wear of the wheels, because it can be reduced by increasing the air gap, as well as by decreasing the normal force. That contradicts however the actual goal of the system.

## 6.2 Analysis on Situation Dependence

First the influences determined in section 6.1 are analyzed regarding occurrence frequency and duration. The regarded influences such as shifting tolerances, storage mistakes, setting in the gravel, and also the wear of wheels and rails, depend on the quality of the installation works, the use duration and the use intensity. For example, setting in gravel of reinstalled rails is larger than of old ones, therefore the air gap is larger with newer rails than with old ones under the same system configuration. Additionally, the setting on the rail course is not constant. The wear of the rails depends on the use of the rail section. Frequently used rail sections show a higher wear than those only rarely used. The wear of the wheels correlates with the use of the shuttle. Shuttles, which are rarely used and have small loads, exhibit therefore a smaller wear than shuttles with higher operating burdens. It can be derived that the air gap is a value depending on distance and time.

The next step is to investigate the characteristic situations for the system shuttle. Only the influences "wear and gear" and "track placement" are regarded here. And on the basis the extreme situations "no track placement"/"no wear and gear" and "track placement"/"wear and gear" are considered.

Beside the air gap, the rotor current  $I_L$  was also identified as a parameter, which affects the drive and brake force and therefore also the efficiency in the section 5.1. The rotor current  $I_L$  is adjusted for the generation of the drive and brake force, depending on the planned driving profile of the shuttle. The demanded driving profiles result from the different situations, in those the shuttles can be and from the requirements in these situations. Typical situations of a shuttle are "start-up procedure in a station", "travelling on an unknown track section", "travelling on an incline", and "damage in the support structure". The shuttles must be differently driven and brake with different forces in these situations. The rotor current is like the air gap also a situation-dependent value. Subsequently, the situations identified for the air gap and the rotor current are combined to the situations specified in the table 1.

## 6.3 Analysis on Objective Dependence

In the first step of the analysis on objective dependence, the adjustable parameters are investigated for each situation, which lead to achieve an optimum efficiency (table 1 center). For example, while the shuttle is "starting from a station", a maximum driving force is required, and the air gap must be small and the rotor current must be large. However, if the environment changes, die to wear of the wheels and rails or by setting in the gravel, the air gap must be increased. The rotor current must keep large in order to produce the necessary strength.

In the second step, every possible objective and their weightings are thought ahead for each situation. The objectives "maximize the drive and brake force", "maximize the security" and "maximize the efficiency" are useful in this example. In order to obtain the optimal parameter in the situations, the objective should be weighted as in table 1 and be traced by the system. In this example, if there are no



Chart 1. Characteristic situations, the parameters to be adjusted and the possible objective combinations to achieve the parameters to be adjusted

Situation		Distinct parameters	objective		
			force <sup>max.</sup>	safety <sup>max.</sup>	efficiency <sup>max.</sup>
Start-up procedure in a station	No wear and tear/ no track placement	$l_{L \text{ high}}, \delta_m \text{ small}$	0,6	0,2	0,2
	Track placement / wear and tear	$l_{L \text{ low}}, \delta_m \text{ big}$	0,4	0,4	0,2
Travelling on an unknown track section	No wear and tear/ no track placement	$l_{L \text{ low}}, \delta_m \text{ small}$	0,2	0,4	0,4
	Track placement / wear and tear	$l_{L \text{ low}}, \delta_m \text{ big}$	0,2	0,6	0,2
Travelling on an incline	No wear and tear/ no track placement	$l_{L \text{ high}}, \delta_m \text{ small}$	0,6	0,2	0,2
	Track placement / wear and tear	$l_{L \text{ small}}, \delta_m \text{ big}$	0,3	0,5	0,2
Damage on the support structure	No wear and tear/ no track placement	$l_{L \text{ low}}, \delta_m \text{ small}$	0,1	0,6	0,3
	Track placement / wear and tear	$l_{L \text{ low}}, \delta_m \text{ big}$	0,1	0,8	0,1

wear and no setting while starting from the station, the objective "force" should have the highest priority. However, if wear or setting in the gravel occurs, the objective security is more important and gets higher weighted.

To the end, a comparison of the objective determined in each situation shows that the system should change the objective to achieve an optimal behaviour. Therefore there is a potential for the application of self-optimization.

#### 6.4 Conceptual realisation of the self-optimization

The following section describes a concept for an optimal air gap adjustment depending on the status of the rail way and the characteristic situations, which are exemplarily specified in the table 1. The basic idea of the concept is "learning from experience" (Figure 6). The shuttles should be able to learn from the experiences of other shuttles. These experiences are made while the shuttles are driving on a certain rail way section. The acquired knowledge should be used for the own objective and for the parameters to be adjusted. For this purpose, each rail way section owns a track section control (TSC). This control provides current distance data and experience data from other shuttles before the own passage. The data form the so called External Preview, which represents the basis for a situation-dependent optimization in connection with the data of the current shuttle. A shuttle, which should drive on a rail way section, can call up these data and adjust the air gap depending to the situation, regarding the rail course and the necessary energy for the adjustment. After passing this rail way section, the shuttle sends back the optimization result and the current air gap distribution to the track section control.

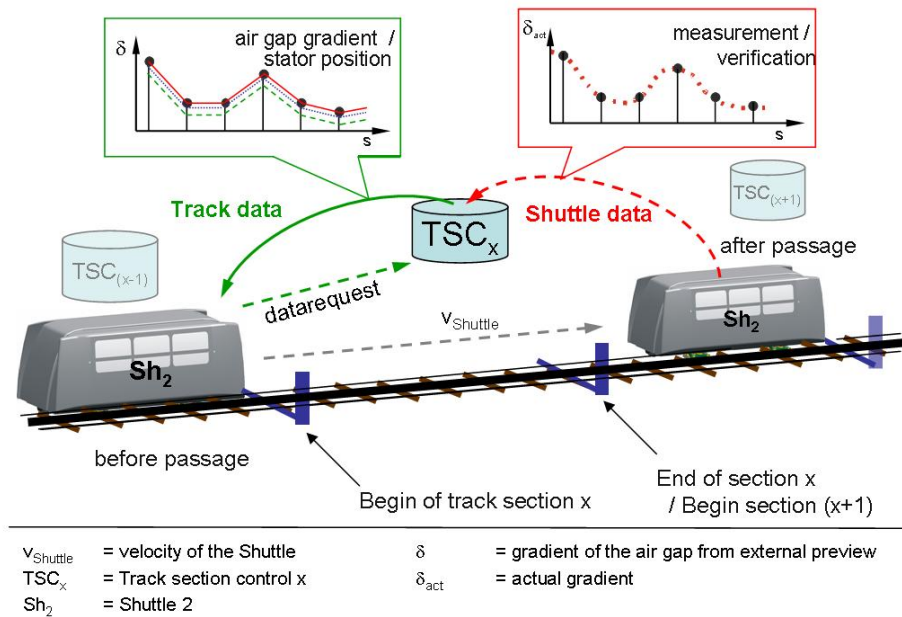

Figure 6. Communication between shuttle and track section control (TSC)

The self-optimization process takes place in the shuttle according to Figure 7. This process is represented in the partial model "behaviour – activities". In the situation analysis, the rail way data, the shuttle default values (force/efficiency/security) and also information from other modules, for example from the energy management, are continuously queried. Furthermore, continuous determination of the completion degree of the current objectives follows. The situation analysis is made in soft-real time. The objective determination of a new system of objectives is specified from the shuttle default values, the default value of other modules of the shuttle and the current objectives. The air gap distribution will be investigated first during the behaviour adjustment. On this basis, suitable parameter and controller variants for the self-optimizing air gap adjustment will be selected in connection with the new system of objectives. The parameters and the controller variants are not only used as optimization results in the shuttle, but are also sent back to the track section control.

## 7 OUTLOOK

The experimental investigations for active air gap adjustment are to be realised on a new conceived hardware-in-the-loop (HIL) test bench at the chair for Construction and Propulsion Technology (KAt). The test bench enables the simulation of a test track and their stator position errors. Furthermore, different driving and route profiles can be produced. This enables the investigation of different actuators regarding their applicability for the situation-related adjustment of the air gap during operation.

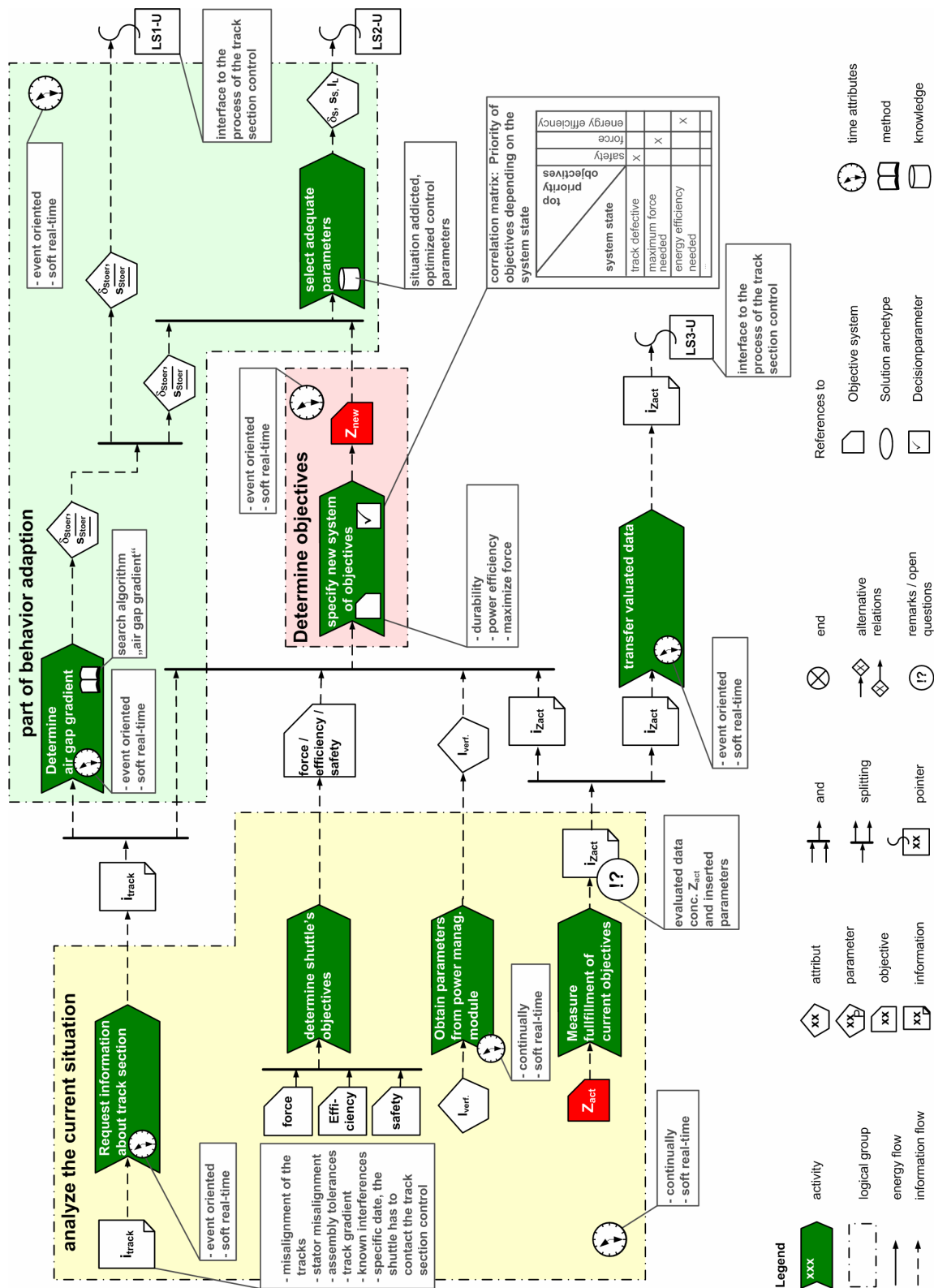

Fig. 7: Subset from a self-optimization process of the air gap module

**SYMBOLS**

- $\eta$  efficiency (of a system)
- $P_{mech}$  mechanical power
- $P_{el}$  electrical power
- $P_V$  dissipation loss
- $F$  drive- and brake force (force)

v	velocity
U	voltage
I	current
$L_{SL}$	mutual inductance of the rotor and stator coils
$I_S$	stator current (primary motor part)
$I_L$	rotor current (secondary motor part)
$\delta$	magnetic air gap
$\delta_m$	mechanical air gap
$\upsilon$	phase angle between stator and rotor current

## REFERENCES

- [1] Pahl, G.; Beitz, W.: *Engineering Design - A Systematic Approach*. Second Edition, Springer Verlag, Berlin, Heidelberg, New York, 1996
- [2] Verein Deutscher Ingenieure (VDI): *Design methodology for mechatronic systems*. VDI-Richtlinie 2206, Beuth Verlag, Berlin, 2004
- [3] Frank, U.; Giese, H.; Klein, F.; Oberschelp, O.; Schmidt, A.; Schulz, B.; Vöcking, H.; Witting, K.; Gausemeier, J. (Hrsg.): *Selbstoptimierende Systeme des Maschinenbaus - Definitionen und Konzepte*. HNI-Verlagsschriftenreihe Band 155, Paderborn, 2004
- [4] Welp, E.G.; Lippold, C.; Bludau, C.: *Ein System zur objektorientierten Modellierung mechatronischer Produktkonzepte (ModCoDe)*. In: VDI Mechatronik Tagung 2001. 12.-13. September 2001, Frankenthal. In: VDI-Berichte Nr. 1631, VDI-Verlag 2001
- [5] Counsell, J.; Porter, I.; Dawson, D.; Duffy, M.: *Schemebuilder: Computer aided knowledge based design of mechatronic systems*. Assembly and Automation. Vol. 19, No.10, 1999
- [6] Suh, N.P.: *Axiomatic Design Theory for Systems*. In: Research in Engineering Design, Springer-Verlag, London Limited, No. 10, 1998
- [7] Buur, J.: *A framework for mechatronics design methodology (ICED)*. In: Proceedings of the International Conference on Engineering Design. London Harrogate, Band 1, London, 1989
- [8] Krause, F.-L.; Tang, T.; Ahle, U.: *iViP - Integrierte Virtuelle Produktentstehung - Abschlussbericht*. Carl Hanser Verlag, Stuttgart, 2002
- [9] Bertram, T.; Petersen, J.; Flores, P.T.; Lapp, A.; Walter M.; Schirmer, J.: *Objektorientierte Ordnungsstrukturen mechatronischer Systeme*. In: Konstruktion (2000). Nr. 10, S.48-50
- [10] Zäh, M.F.; Lercher, B.; Thiek, S.: *Adaption von Techniken des Software-Engineering für die Mechatronik*. In: Konstruktion (2002-11/12). S.56-58
- [11] Gausemeier, J.; Frank, U.; Steffen, D.: *Specifying the principle solution of tomorrow's mechanical engineering products*. In: Proceedings of the DESIGN 2006, 9th International Design Conference, Dubrovnik, Croatia, 2006
- [12] Hansen, C.; Ahmed, S.: *An Analysis of Design Decision-Making in Industrial Practice*. In: Proceedings of the 7th International Design Conference DESIGN 2002. 14.-17. Mai, 2002, Dubrovnik, Croatia, Vol. 1, 2002
- [13] Zimmer, D.; Schmidt, A.: *Der Luftspalt bei Linearmotor-getriebenen Schienenfahrzeugen (Antriebstechnik, Ausgabe 2/2005)*
- [14] Grothstollen, H.: *Regelung elektrischer Antriebe*, Skript der Vorlesung, Universität Paderborn 2002
- [15] Zimmer, D.; Böcker, J.; Schmidt, A.; Schulz, B.: *Elektromagnetische Direktantriebe im Vergleich (Antriebstechnik, Ausgabe 2/2005)*

Contact: Prof. J. Gausemeier  
 Heinz Nixdorf Institute, University Paderborn  
 Fürstenallee 11  
 33102 Paderborn  
 Germany  
 Phone +49 5251 606267  
 Fax +49 5251 606268  
 e-mail juergen.gausemeier@hni.upb.de